

DYNO
USER'S
MANUAL



MORRISVILLE, VERMONT USA 05661 EMAIL:ROWING@CONCEPT2.COM WEB:WWW.CONCEPT2.COM

Table of Contents

SAFETY	3
INTRODUCTION	4
FORCE MONITOR USE	5
Basic Operation	6
Advanced Operation	7
Recall Mode	7
Second Function of Buttons	8
GETTING STARTED	9
TRAINING	
Dampers, Speed, Force & Training	12
“Lift” Variations	14
Logging Your Results	15
CARE & MAINTENANCE	18
WARRANTY	18
DYNO QUICK REFERENCE GUIDE	19

SAFETY

CAUTION

- Be sure to do at least five minutes of cardiovascular exercise and some stretching as a warm-up before lifting. Rowing makes a great warm-up because it uses the same muscle groups as the *DYNO*.
- Keep children, pets, and bystanders away from the *DYNO* while you are using it. In particular, the moving carriage could pinch fingers.

WARNING

- **IMPORTANT:** Do not attempt to lift a free weight of the same amount that you can push on the *DYNO*. The *DYNO* lift is not limited by your “weak point” of the motion. Therefore, the *DYNO* force reading may be greater than the amount of free weight you can lift.

INTRODUCTION

DYNO - short for Dynamometer, a device which measures force.

Dynamic Strength Training

The Concept2 *DYNO* is based on the concept of dynamic strength training. The resistance you feel is a direct response to your effort. The more force you are capable of applying to the *DYNO*, the more you "lift." A measurement of your effort for each repetition will be displayed.

Think about traditional weight lifting. The amount of weight you can lift is limited by your weakest point in the lift. Your stronger parts of the lift may not be challenged. Dynamic Strength Training enables your muscles to be fully challenged throughout the movement, because the resistance is created in dynamic response to your effort. At the points in the "lift" where you are able to push harder, the resistance will be greater.



Description of the Machine

The heart of the *DYNO* is a flywheel, specially designed to produce a range of resistance levels suitable for strength training. The amount of air reaching the flywheel is controlled by eight damper levers on the flywheel housing. These dampers affect the load that you have on the wheel. The more dampers that are open, the harder the *DYNO* will feel at a given speed of movement.

The *DYNO* has three basic positions: leg press, seated bench press, and bench pull. These three movements provide a basic strength foundation for many sports and activities. The "lifts" are done by pushing or pulling a carriage which rides on a monorail. The *DYNO* also allows you to build on the basic "lifts" by making a number of variations, which exercise slightly different muscle groups.

The Force Monitor gives you accurate and immediate feedback on your effort. It also displays your maximum effort and calculates an average at the end of the set.

Terminology

- Rep - short for repetition. Each press or pull that you do is one rep.
- Set - a group of reps is called a set.

Description of Display

Top left:

This display counts down the warm-up reps. When you start, you will see: START IN 3 REP. If the set/rest time is turned on by pressing the TIMER button, this display will show the elapsed time for the set, then the elapsed time for the rest.

Top right:

After the warm-up, this display shows how many reps you have done. For example, it will show REP 5 when you have completed your fifth rep.

Center:

- During each set: This display shows the force exerted on the rep just completed. 140 LBS means you have generated an average force of 140 lbs over the entire range of the "lift" just completed. You may choose between units of LBS or KG.
- After each set: Ten seconds after the last rep is completed, this display will change to show the average of all the reps in the set.

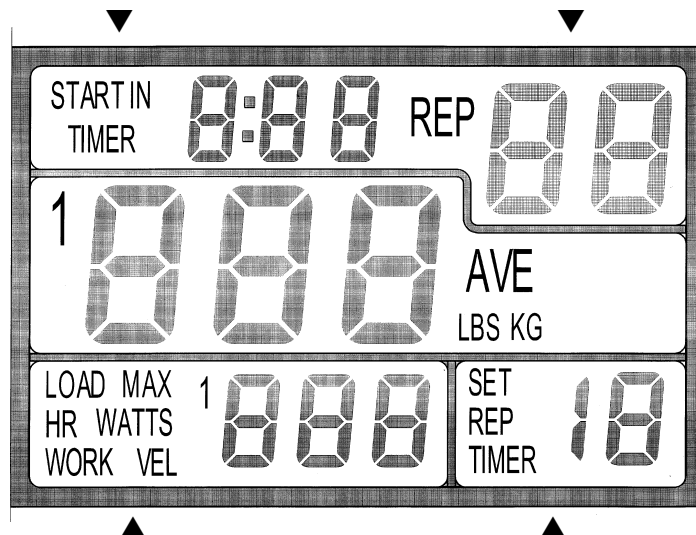

Lower left:

This display shows your maximum force for the set. You may choose between units of LBS or KG. You may also choose to view other data in this display, including power (watts), heart rate, work (newton-meters), load, and velocity (mm/sec).

Lower right:

- During each set, this display shows the REP TIMER, which counts the elapsed time since the completion of the last rep.
- After each set: This display shows the number of completed sets.

View of Force Monitor Button Panel

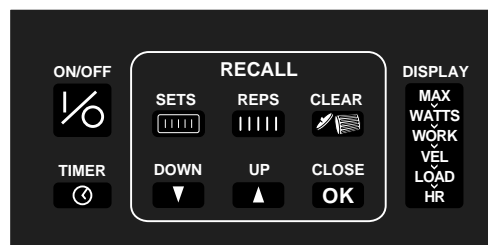

Basic Operation

Power-Up: The Force Monitor has been designed to start automatically when you begin lifting. No button pushing is required.

Start in 3 Reps: The Force Monitor will count down the first three reps as warm-up reps, during which no force data will be displayed. This allows you to start every set with three easy warm-up reps.

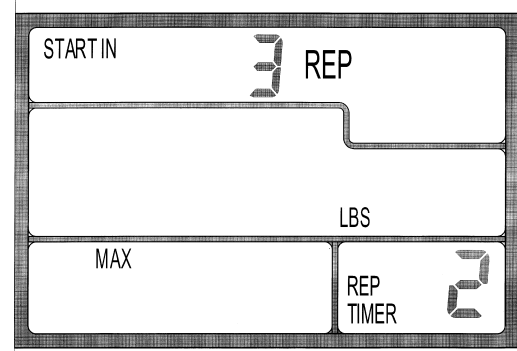

Workout Data: After the warm-up, the Force Monitor will automatically display your workout data as follows:

- Center display - your force reading for each rep, and the average of all your reps at the end of the set
- Bottom left - your maximum force reading for the set.
- Top right - the number of reps completed.
- Bottom right - the elapsed time since your last rep, and the number of sets completed at the end of the set.

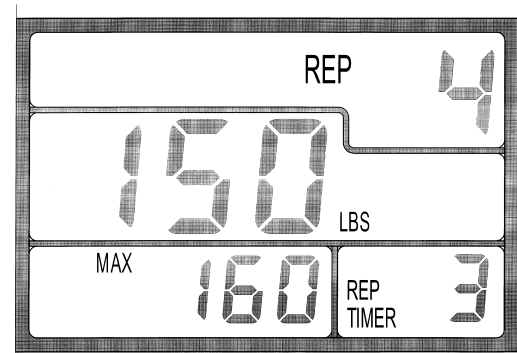

End of Set: The monitor determines that your set is finished if ten seconds elapses since the beginning of the last rep without another rep occurring. You can watch the rep timer in the lower right display to be sure you start your next rep within ten seconds, unless you are done with your set. Your set summary data will automatically be displayed ten seconds after completion of your last rep.

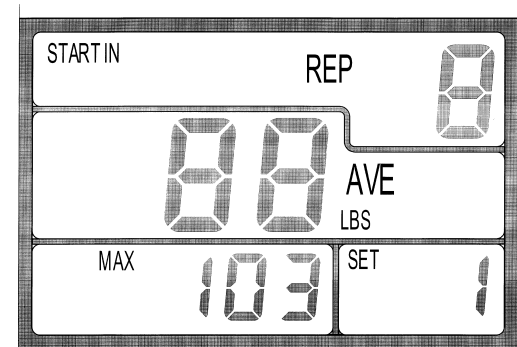

Pounds or Kilograms: To cycle the units between pounds and kilograms in the central display, press OK and the UP arrow. After powering down, the monitor will come back up in the units you last used.

Automatic Power Down: The monitor will power down automatically after ten minutes of no activity. It can also be turned off using the I/O button.

Advanced Operation

Button Functions

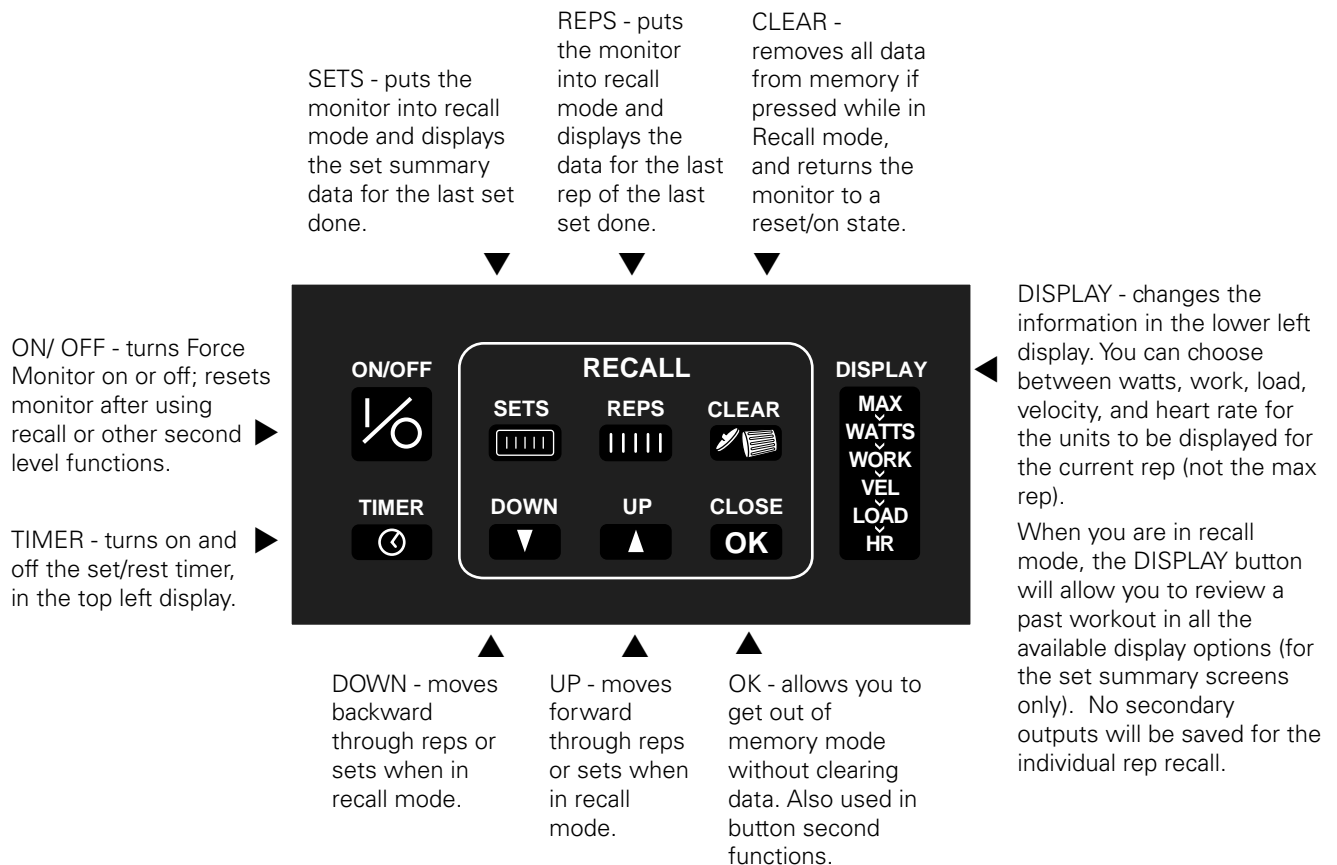

Recall Mode

Features

- RECALL enables you to save up to 19 set summary screens and over 300 rep screens.
- When either limit is reached, the oldest data will be dropped first.
- Workout data is stored as reps within sets. Example: set 1 (rep 1, rep 2,...) set 2 (rep 1, rep 2,...)
- After the CLEAR button is pressed, the first set completed will be set 1.
- The memory will save all sets and reps during power down, but will be automatically cleared before rep 1 of the first set after a full power-down. (A full power-down occurs when the dash in lower right hand display completely disappears).
- The first set to be recalled will be the most recently completed set.

NOTE: If a new user starts to work out, their sets will just be added to memory. i.e. their first set may be set 17 if they have not cleared memory.

Using the memory buttons:

- Upon completion of the last rep, the “results screen” will be displayed. At this point the monitor is not in the memory mode.
- If the user presses the SETS or the REPS button while in the “results screen” (or in an “ON” state activated by pressing the ON button) the monitor goes into recall mode.
- If the recall mode is entered by pressing SETS, the first screen is the set summary screen for the most recent set. This set summary screen is similar to the result screen except the rest time is replaced by the set time and the DOWN/UP (▼ / ▲) buttons will scroll you through the set numbers.
- If the recall mode is entered by pressing REPS, the rep recall screen for the last rep of the last set will show. The rep enunciator should flash to show that you have selected reps and the DOWN/UP (▼ / ▲) buttons will move through the reps. The rep recall screen shows the rep #, the force, and the set #.
- At any time during review of reps, if the SETS button is pressed, the set summary screen will appear for the current set being viewed and the DOWN/UP (▼ / ▲) buttons will move through the set summary screens.
- At any time during the review of the set summary screens if the REPS button is pressed, the rep recall screen for the last rep of that set will show. The rep enunciator should flash to show that you have selected reps and the DOWN/UP (▼ / ▲) buttons will move through the reps.

Getting out of memory mode

- Pressing CLEAR will remove all data from memory and return the monitor to a reset / on state.
- If the user wants to get out of memory without clearing the data, press the OK (close) button. Remember that if the monitor powers down, it will automatically clear memory before rep 1 of the first set after power-up.

Second Function of Buttons

OK + UP - toggles between LBS and KG for the units in the central display. It can be done at any time, i.e. in the middle of a set or while recalling from memory. The monitor should power up in the units that were last selected.

OK + REPS - Lets you view the resettable rep counter. Pressing CLEAR while viewing resettable reps will zero the counter.

OK + SETS - Lets you view your total work in thousands of newton-meters. Pressing CLEAR while viewing resettable total work will reset work to zero.

OK + DOWN - lets you view the non-resettable rep counter displayed in thousands of reps.

GETTING STARTED

Your first workout should focus on getting accustomed to the motions of the three basic “lifts.” learning about the operation of the Force Monitor as described on pages 4-7, and determining the settings that are most comfortable for you. If you have been doing regular weight training workouts, you may feel comfortable pushing harder during your first *DYNO* workout. If you have not been doing any weight training, start easily and give yourself a few workouts to build up to full effort.

Terminology

- Rep - short for repetition. Each press or pull that you do is one rep.
- Set - a group of reps is called a set.
- Compression - the amount of bend in your knees when you start the leg press. The lower the number on the compression scale the greater your leg compression.

“Lift” Positions and Recommended Settings:

We recommend that you start with the following settings:

1) Seated Bench Press

- a) Handle height: Loosen the knob that holds the handles on the vertical post. Set the bar height so that the handles are about three inches below your shoulders. Tighten the knob.
- b) Damper levers: Start in the range of 1-2 dampers open.
- c) Compression: Let the bar return until it just touches your chest.
- d) Start position: Start with the handles close to your body and press them straight away from your chest until your arms are straight.



Start



Finish

2) Leg Press

- a) Set the handle high enough to be out of the way of your knees.
- b) Foot height: Adjust the Flexfoot so that the ball of your foot rests on the flat stationary section of the Flexfoot.
- c) Damper levers: Start in the range of 2-4 dampers open.
- d) There is a pair of handles under the seat to hold on to during the leg press.
- e) Watch to see what compression reading you naturally achieve. Most people should aim for a compression of between 6 and 12. Those with shorter legs should aim for smaller compression numbers; those with longer legs should aim for larger numbers. Your force reading will vary greatly at different compression starting points. This is because more compression puts your body into a "weaker" position. The smaller force applied at this weaker position will be averaged into the reading for that rep, thus giving a lower value.
- f) Start position: Start the press with your legs comfortably compressed and extend them until they are just straight, but not hyper-extended.



Start



Finish

3) Seated Bench Pull

- a) Handle height: Loosen the knob that holds the handles on the vertical post. Set the bar height so that the handles are about five inches below your bench press setting. Tighten the knob.
- b) Damper levers: Start in the range of 1-2 dampers open.
- c) Sit with your knees far enough apart to allow the carriage to travel all the way to the chest support.
- d) Start position: Start the pull with arms fully extended.
- e) Finish position: The pull is complete when you have pulled the handles all the way to your body or just past the seat back.



Start

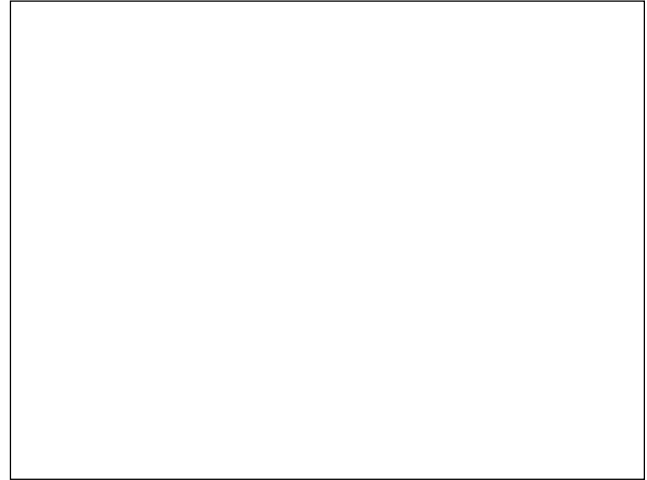

Finish

Your First Session:

- Be sure to do 5-10 minutes of cardiovascular activity as a warm-up.
- Stretch.
- Order of "Lifts": Start with one of the upper body "lifts" (Seated Bench Press or Seated Bench Pull), then do the Leg Press, and finish with the remaining upper body lift.
- Protocol: A typical protocol for general strength improvement is three sets of eight reps. (In other words: 8 reps, rest, 8 reps, rest, 8 reps.) If this feels like too much, just do one or two sets. If you are accustomed to another protocol from standard weight lifting, you may wish to apply it to the *DYNO* as well.
- Work gently at first, applying only as much pressure as is comfortable. Remember, the harder you push, the harder it will feel. Watch the monitor and get used to how it feels at different force numbers.
- Watch your compression on the Leg Press to see what amount of compression is natural and comfortable for you. Record this in your log.
- Use your first session to get comfortable. If you feel that a "lift" would be more comfortable if you adjusted your settings, go ahead and change them. When you are comfortable, record all settings so you can duplicate them for your next *DYNO* session.

By the end of the first workout, you should have established your settings and compression targets. For subsequent workouts, it will be important to keep these variables consistent in order to be able to accurately monitor your progress. You will also have an idea of how much force you can apply and what the set average means.

The damper levers affect the air flow to the fan, which in turn determines how fast the *DYNO* carriage will move when a given force is applied.

- When more dampers are open, you will tend to achieve a higher force but at a slower speed of movement.
- When fewer dampers are open, you will tend to achieve a lower force but at a faster speed of movement.

There is a relationship between the speed of an athlete's movement and their ability to generate force through muscular function. The slower the speed of movement, the greater the force that can be generated (up to a point). Generally, to improve strength, you need to train at a slower speed than you would normally use in your sport so that you can apply a higher force to challenge your muscles and cause an improvement in your strength.



Three dampers open.

Based on this premise, we have listed some possible training strategies below:

Strategy #1: Building Maximum Strength

The goal of this strategy is to exert the maximum force you can each repetition for a small number of repetitions. You are continually trying to achieve a new personal record (PR). Experiment with the dampers so that you are working with the smallest number of open dampers that still allows you to achieve your maximum force reading. This keeps you from straining at too slow a speed of movement, while still enabling you to work at maximum force.

of open dampers: minimum that lets you achieve maximum force.

of reps: 8 or fewer.

Go for max force each rep.

Do 2 - 3 sets of the number of reps chosen.

Strategy #2: Improving Ability to Apply High Force at Faster Speed

After you have achieved adequate maximum strength (or concurrently if you wish) you can work toward improving your ability to deliver your force at faster speeds of movement. Decrease the number of open dampers by 2 or more, and work on building your ability to achieve high force readings despite the faster speed.

of open dampers: 2 or more fewer than in Strategy #1.

of reps: 12 or fewer.

Go for max force each rep.

Do 2 - 3 sets of the number of reps chosen.

Strategy #3: Improving Muscular Endurance

The goal here is to improve your ability to do many reps of an exercise, still at a higher force and slower speed than would normally be used in your sport.

of open dampers: the same or fewer than in Strategy #2.

of reps: 20 or more.

Go for best average force.

Suggested Workout Frequency: One to three times per week. If you are lifting three times per week and you find that you are reaching a plateau in your progress, try dropping one session. If you are lifting just once per week and are not seeing progress, try adding a second session.

Note on Making Damper Changes: The Force Monitor is self-calibrating so that it is accurate regardless of damper settings. The built-in warm-up reps allow the monitor to adjust for any damper changes before the set begins. For this reason, it is important that damper changes be made before the warm-up cycle of a set.

Strategy #4: Improving Anaerobic Threshold

Both aerobic and anaerobic capacities begin to decline as early as age 30 and VO2 max decreases about 1% per year after the age of 50. Anaerobic capacity deteriorates three times as fast. To stimulate the anaerobic energy systems, try to perform the following workouts once or twice a week.

#1 DYNO Leg Press: Press as many reps with as high a power output as possible in 30 seconds followed by a two-minute recovery period.

#2 DYNO Arm Pull and Push: Same as above.

Note: Because the anaerobic energy systems are maximized at 40-60 seconds and because you need sufficient time to clear and metabolize the lactate produced, all of these workouts will offer an effective challenge to the anaerobic energy system.

“Lift” Variations

Leg Press variations:

- You can set the height of your feet.
- You can increase or decrease the amount of leg compression.
- You can change the number of open dampers to alter the speed at which your force is applied.

Seated Bench Press variations:

- You can set the height of the bar.
- You can use a wide hand grip, or grip the bar with hands closer together.
- You can grasp the bar with palms down or palms up.
- You can change the number of open dampers to alter the speed at which your force is applied.

Seated Bench Pull variations:

- You can set the height of the handles.
- You can rotate the handles to allow you to pull palms facing down, up, or inward.
- You can change the number of open dampers to alter the speed at which your force is applied.

IMPORTANT: Because of the many variations possible, it is extremely important that you maintain consistency in your settings if you wish to monitor your results. For example, a decrease in leg compression on the Leg Press will always result in higher scores. Therefore, if you want to be able to measure true improvement in your leg strength, you need to maintain the same degree of compression every time you do the Leg Press. (Compression refers to the amount of bend in your knees when you start the press. The lower the number on the compression scale the greater your leg compression.)

It is also important to keep consistency in your lifting protocol. For optimal comparability, you should choose a protocol and stick with it, until you consciously decide to make a change. For example, a common protocol for strength improvement is three sets of eight repetitions.

Log pages are provided on pages 16 and 17 in this manual which will prompt you to record the important variables to ensure that you are being consistent with your lifts.

Logging Your Results

Starting with your second *DYNO* workout, you should log all your workout results. This will enable you to monitor your progress over time. Log sheets are provided in this booklet. You may make as many copies as wish.

Workout Logging:

The log sheets are designed to help you maintain consistency in your *DYNO* variables. See the sample log sheets on pages 16 and 17 of this manual. Specifically, you should record and keep consistent the following variables:

- Number of open dampers.
- Height setting of the handle bar.
- Degree of compression.
- Orientation of hand grip (up, down, wide, narrow).
- Number of reps per set.
- Number of sets per session.

In order to be able to compare your results from one workout to the next, you must keep all these variables the same.

If you decide to increase the number of open dampers as your strength increases, be sure to record it, and be aware that your results will not be directly comparable to those at the lower number of open dampers.

If you do variations of a basic movement, you should record these results as separate "lifts." For example: If you do bench press both with a wide grip and a narrow grip, these would be recorded separately as you will get two different sets of results.

Longitudinal Analysis:

We have also provided you with a graphing log sheet format for logging your progress over time. See page 17.

1. Use one sheet for each "lift."
2. Take your best set for each day and write the max and average values at the bottom of the chart as shown on sample graph at right.
3. Plot your first points about one-third of the way up the graph as shown on this sample graph.
4. Once you plot your first points, you can write in the scale along the vertical axis, using each square to represent five pounds.
5. If you improve so much that you move off the chart, start again on another sheet.

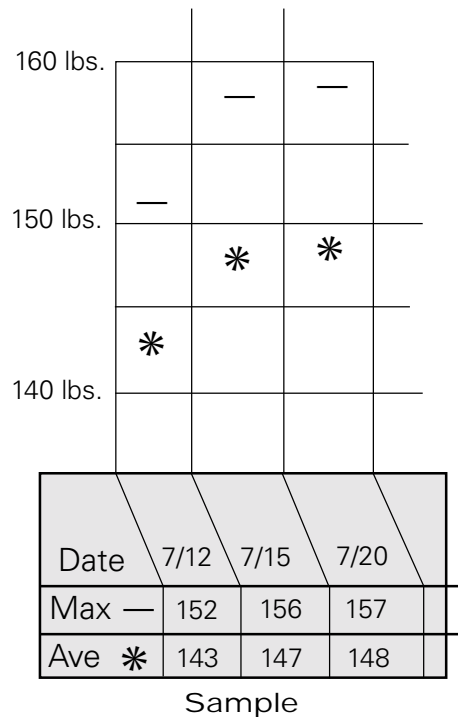

NAME: _____	Leg Press Specs reps per set _____ # of open dampers _____ compress to rail # _____ other:	Arm Press Specs reps per set _____ # of open dampers _____ vertical height setting _____ other:	Arm Pull Specs reps per set _____ # of open dampers _____ vertical height setting _____ other:
--------------------	---	--	---

DATE	SET#	MAX	AVE	COMMENTS	MAX	AVE	COMMENTS	MAX	AVE	COMMENTS

Longitudinal Analysis Graph Lift: _____

M A X & A V E R A G E L I F T

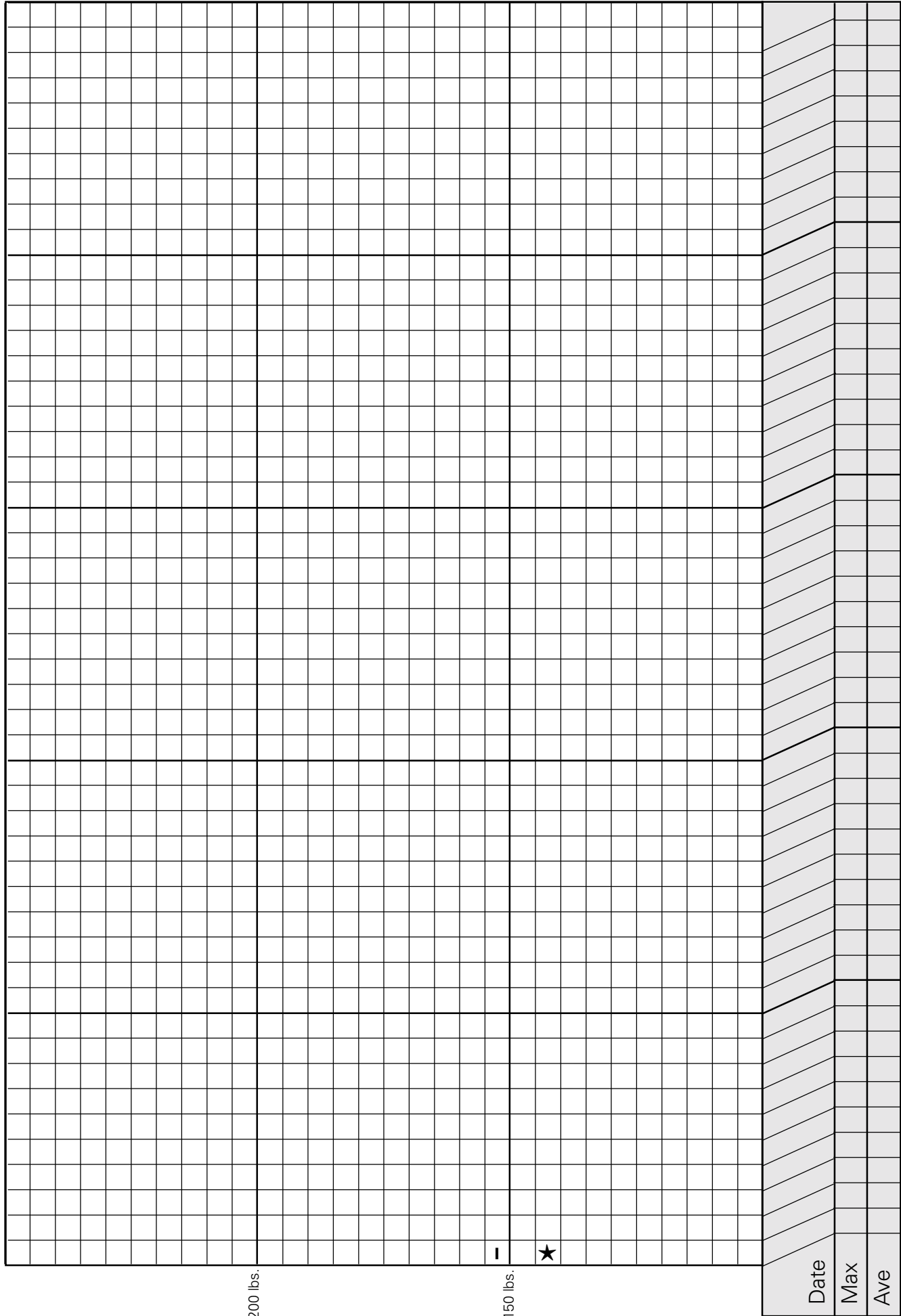

Key: - MAX ★ Avg Note: each square equals 5 lbs.

CARE & MAINTENANCE

The *DYNO* requires minimal care and maintenance, but we do recommend that the following procedures be performed regularly to prolong the life of the machine.

- Clean the monorail at least weekly - use a cloth or paper towel with water or a household spray cleaner to wipe sweat and dirt off the rail.
- Oil chain several times per year or more frequently as needed. Use the chain oil provided. Apply oil to a paper towel and run it over the chain as someone gently uses the machine to move the chain for you.
- Oil the threads of the handle tightening knob when you oil the chain, or more frequently as needed.
- Check all nuts and bolts for tightness monthly.
- Damper lever tension can be adjusted by tightening or loosening the screw at the pivot point of the lever. A fraction of a turn on the screw will make a significant change in tension.

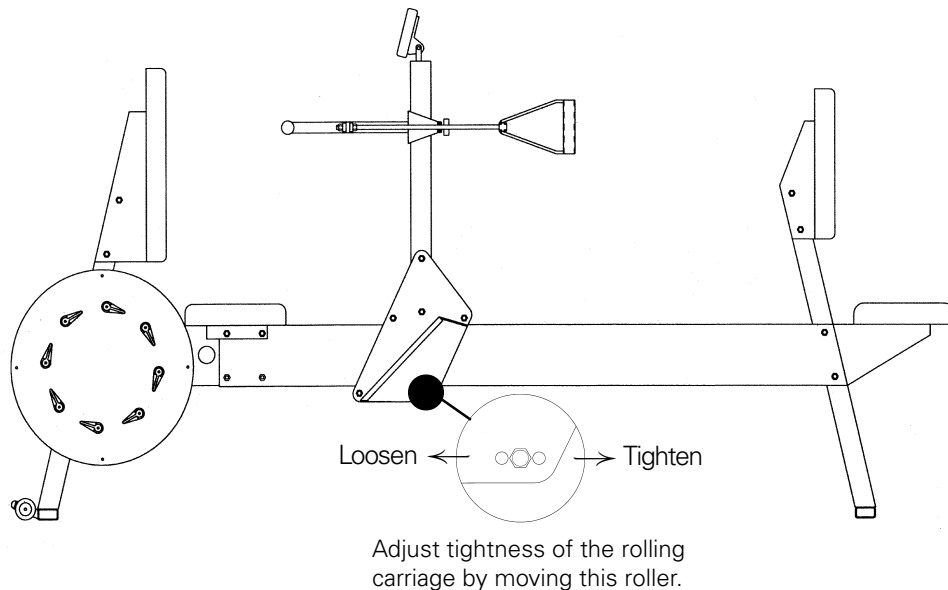

WARRANTY

Five years on metal frame parts, and two years on all other parts.

DYNO Quick Reference Guide

- Warm up with at least five minutes of continuous exercise before performing high force repetitions.

CAUTION • Keep feet apart for seated bench press and seated bench pull so carriage does not hit your legs.

CAUTION • Keep other people away from moving carriage when in use.

- Monitor will automatically begin a new set when the carriage is activated. The first three reps are not recorded and serve as extra warm-up and allow the monitor to adjust for any damper changes.
- Eight damper levers control the load that you feel at a given speed of movement. NOTE: Damper levers should not be changed once a set has been started.
- The set will end automatically if ten seconds has passed since the beginning of the last rep.
- When a set has ended, the set summary data will be displayed.
- Set summary data and individual rep data may be recalled using the RECALL buttons. The memory can be emptied with the CLEAR button. The OK button exits recall mode without clearing memory. The memory will also clear automatically just before the first rep of the first set after a power down.
- In order to be able to compare your results from one workout to the next, you should record and keep consistent the following variables: number of open dampers, height setting of the handle bar, degree of compression, orientation of hand grip (up, down, wide, narrow), number of reps per set, and number of sets per session. The set max and average are only comparable if the variables are held constant.
- The TIMER button turns on or off the SET/REST button in the upper left display.
- The DISPLAY button cycles between five options for the data shown in the bottom left display.

WARNING • **IMPORTANT SAFETY NOTE:** Do not attempt to lift a free weight of the same amount that you can push on the *DYNO*. The *DYNO* lift is not limited by your “weak point” of the motion. Therefore, the *DYNO* force reading may be greater than the amount of free weight you can lift.

